

PIK. 2214,13

Skale 1:100/1:100

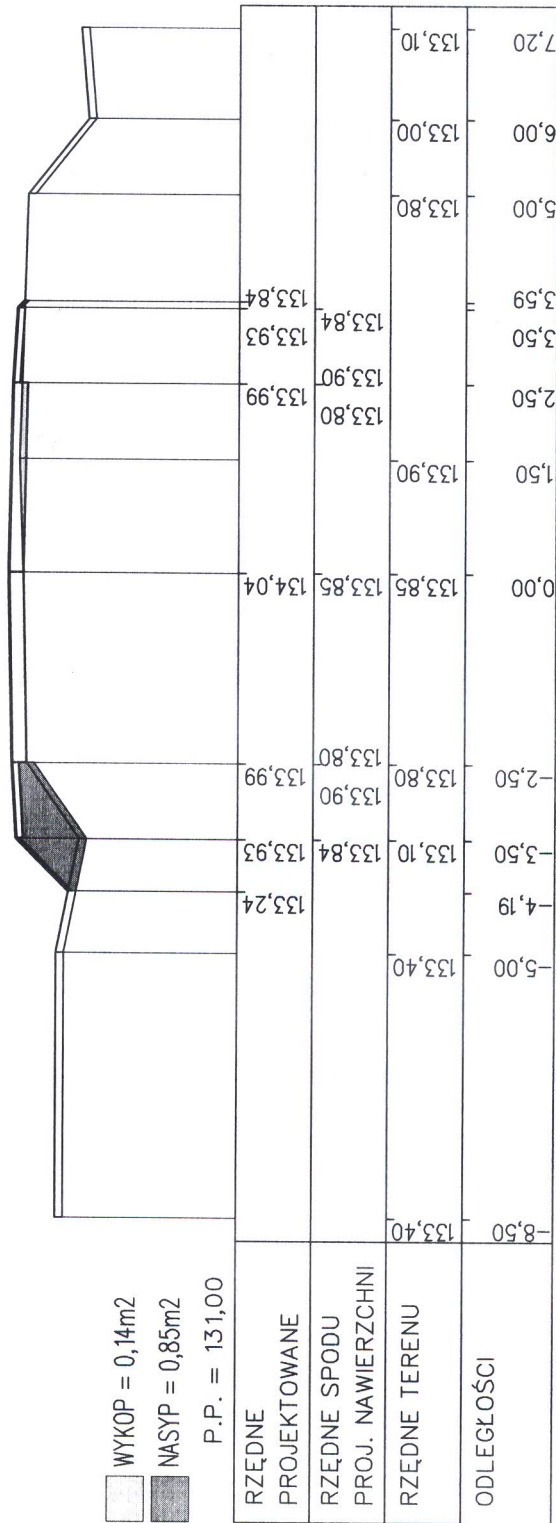

WYKOP = 0,14m<sup>2</sup>

NASYP = 0,85m<sup>2</sup>

P.P. = 131,00

PIK. 2264,47

Skala 1:100/1:100

WYKOP = 0,00m<sup>2</sup>

NASYP = 0,70m<sup>2</sup>

P.P. = 130,00

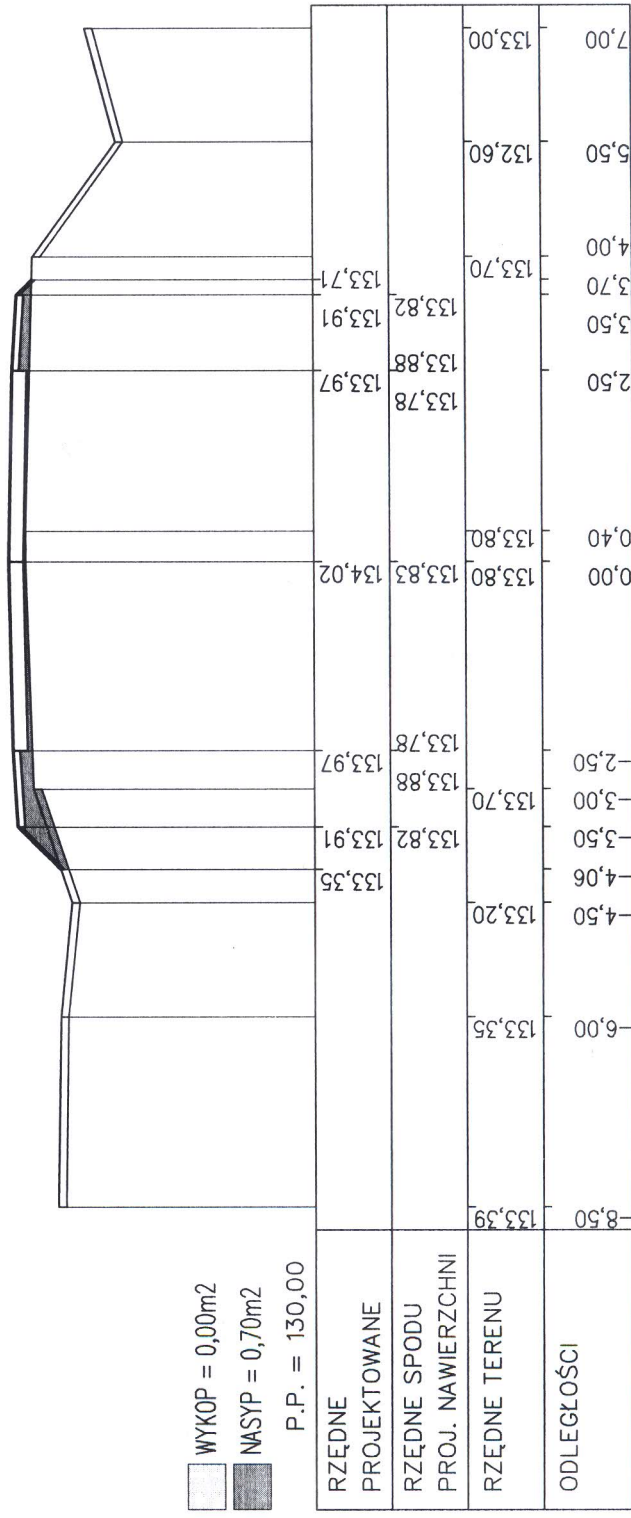

PIK. 2354,64

Skale 1:100/1:100

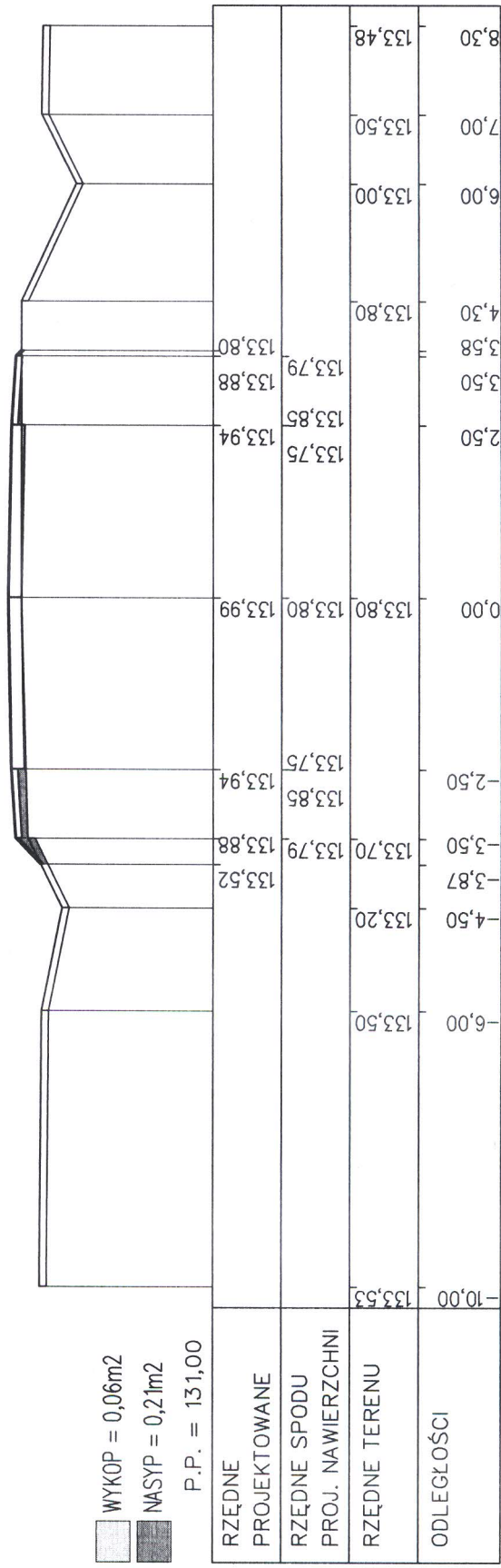

PIK. 2414,74

Skala 1:100/1:100

WYKOP = 0,00m<sup>2</sup>

NASYP = 0,24m<sup>2</sup>

P.P. = 131,00

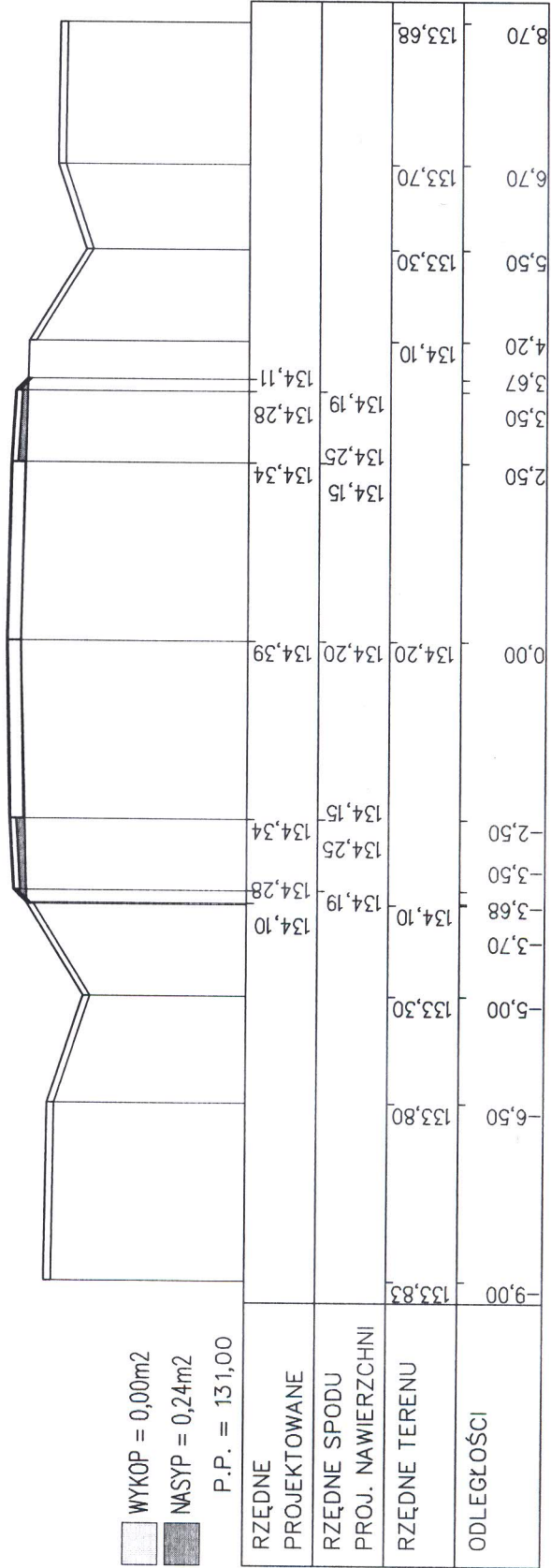

PIK. 2519,06

Skale 1:100/1:100

WYKOP = 0,21m<sup>2</sup>

NASYP = 0,34m<sup>2</sup>

P.P. = 131,00

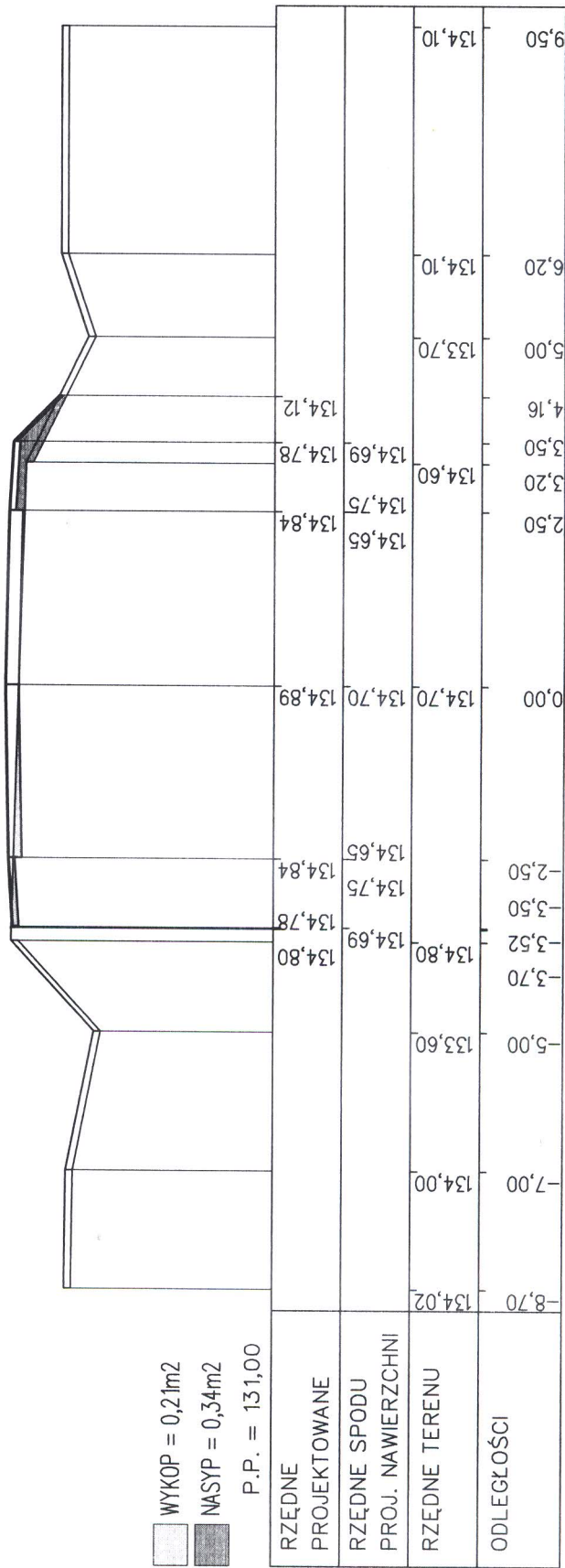



PIK. 2565,51

Skale 1:100/1:100

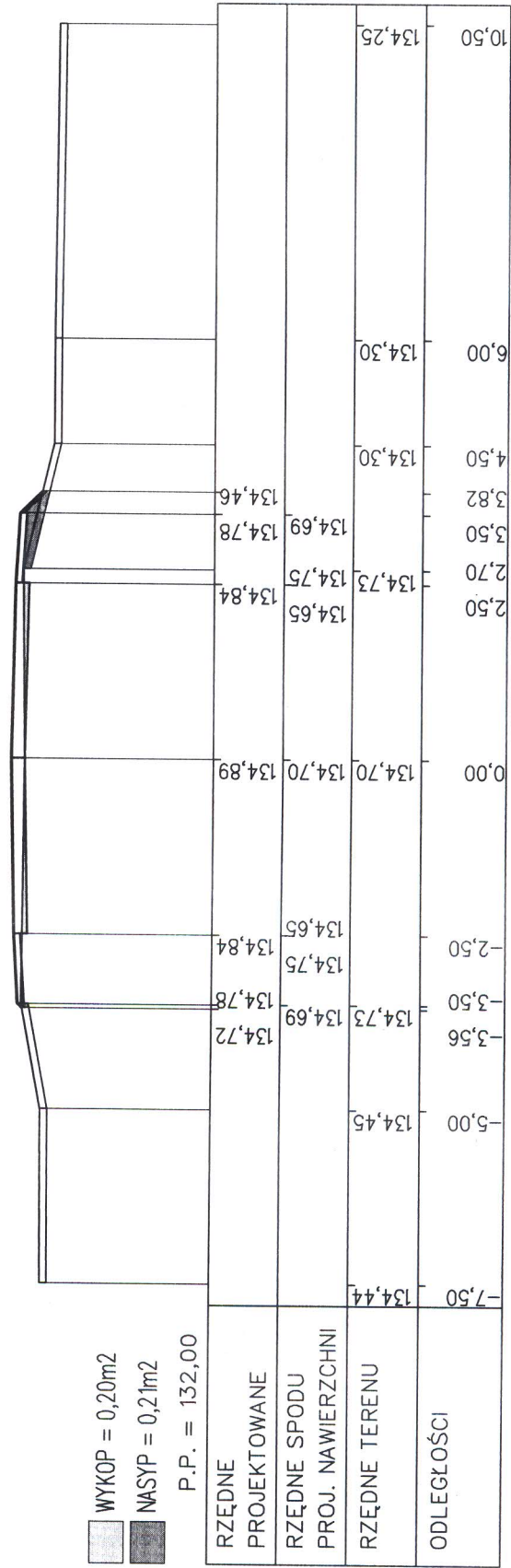

WYKOP = 0,20m<sup>2</sup>

NASYP = 0,21m<sup>2</sup>

P.P. = 132,00

PIK. 2613,22  
 Skale 1:100/1:100

WYKOP = 0,35m<sup>2</sup>  
 NASYP = 1,95m<sup>2</sup>  
 P.P. = 131,00

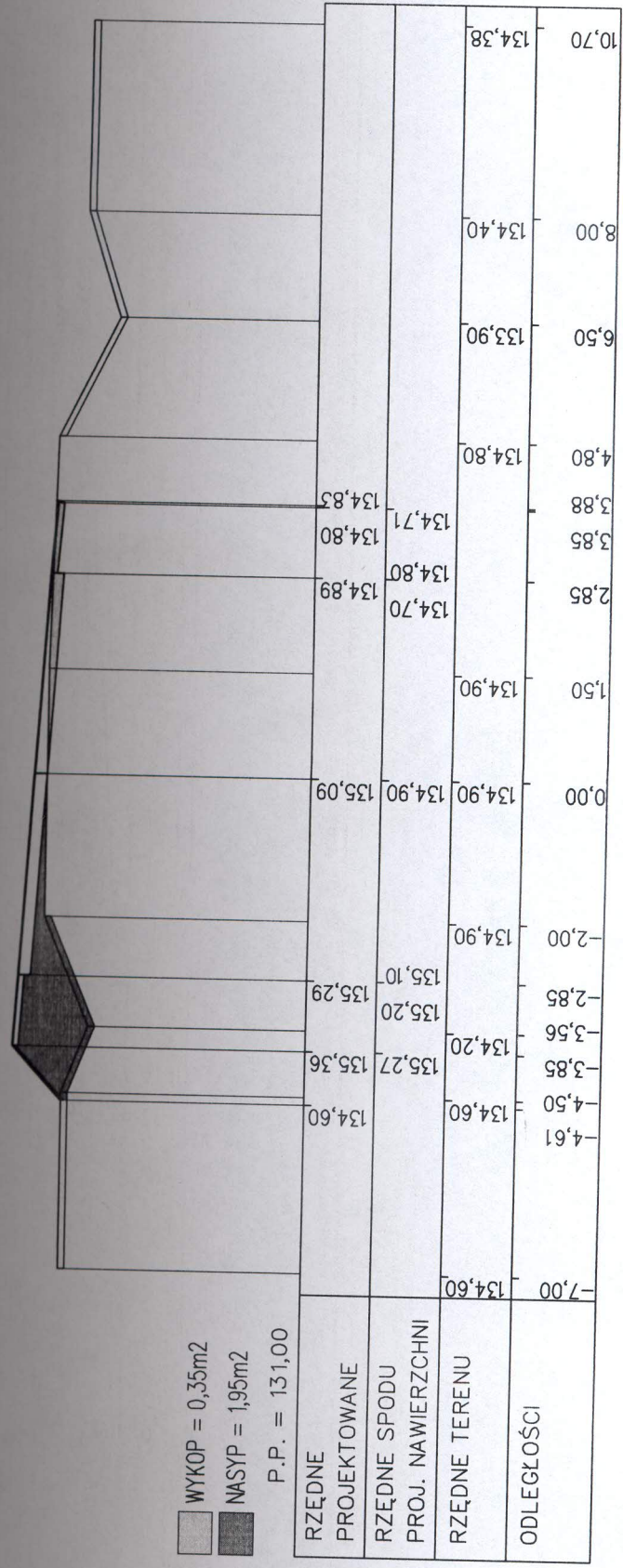

PIK. 2664,20

Skale 1:100/1:100

WYKOP = 0,27m<sup>2</sup>

NASYP = 1,54m<sup>2</sup>

P.P. = 132,00

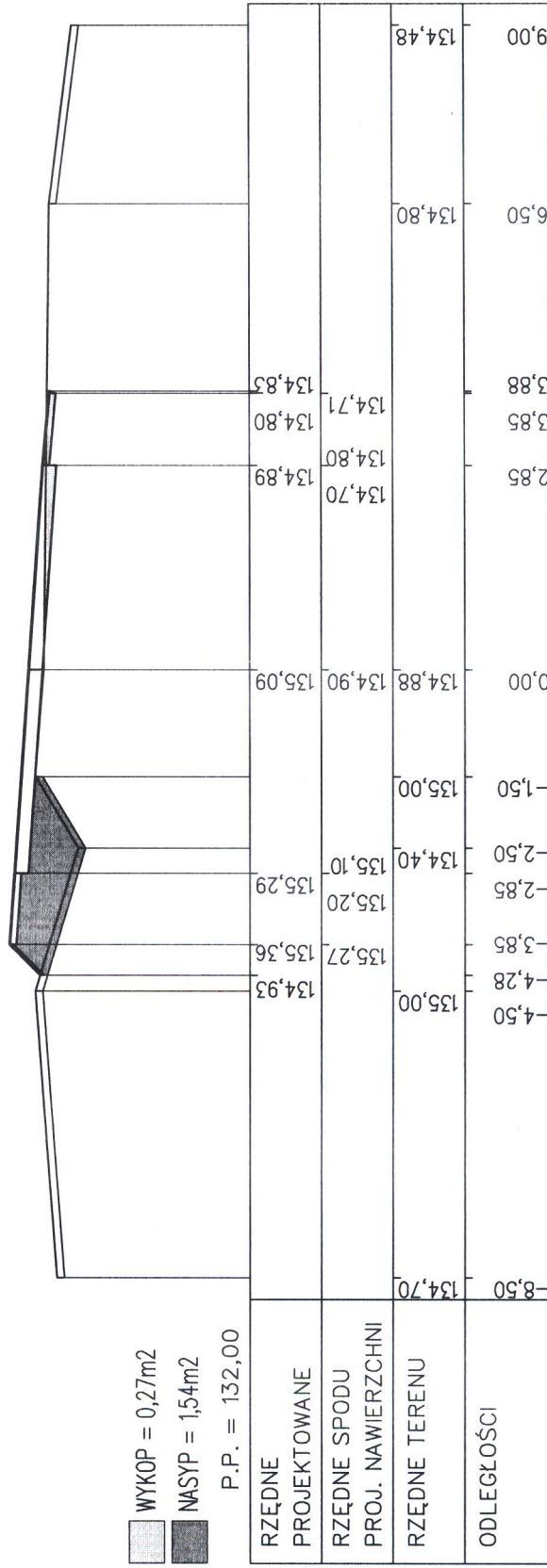



PIK. 2775,62

Skala 1:100/1:100

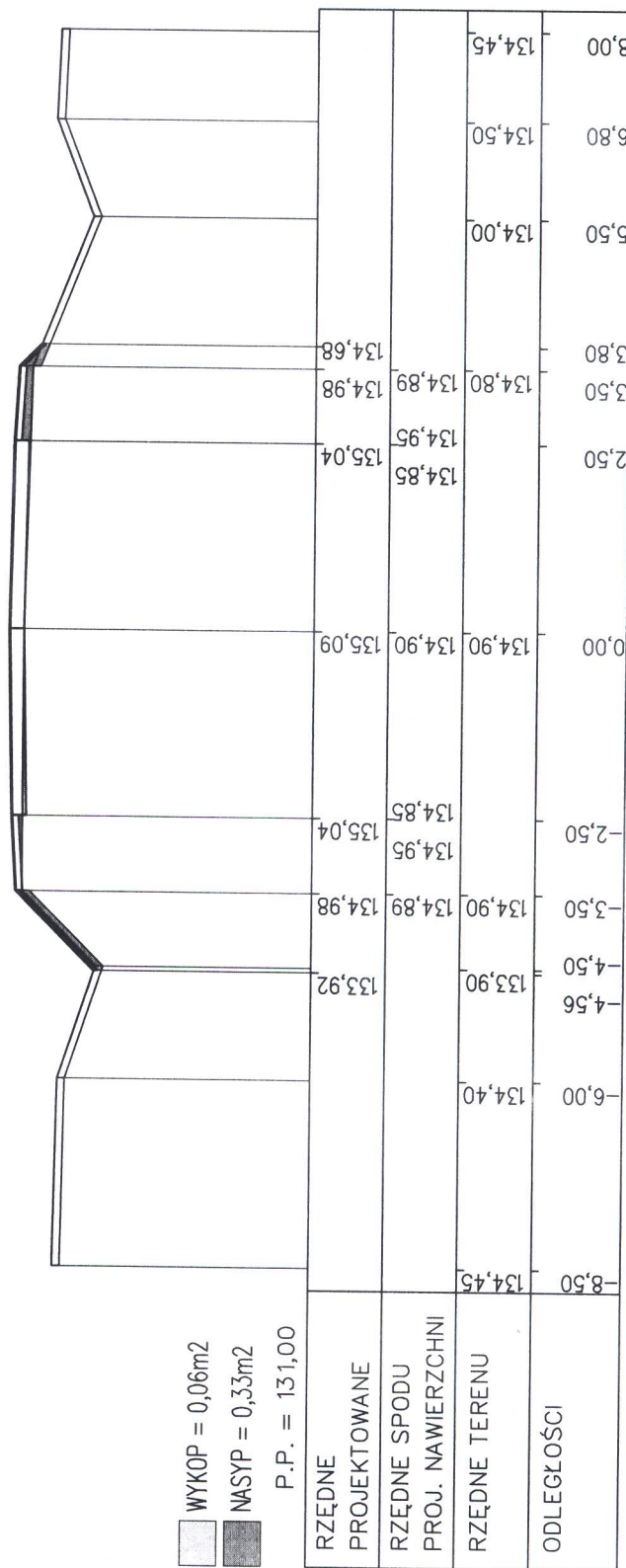

WYKOP = 0,06m<sup>2</sup>

NASYP = 0,33m<sup>2</sup>

P.P. = 131,00

PIK. 2879,38

Skale 1:100/1:100

WYKOP = 0,07m<sup>2</sup>

NASYP = 0,43m<sup>2</sup>

P.P. = 131,00

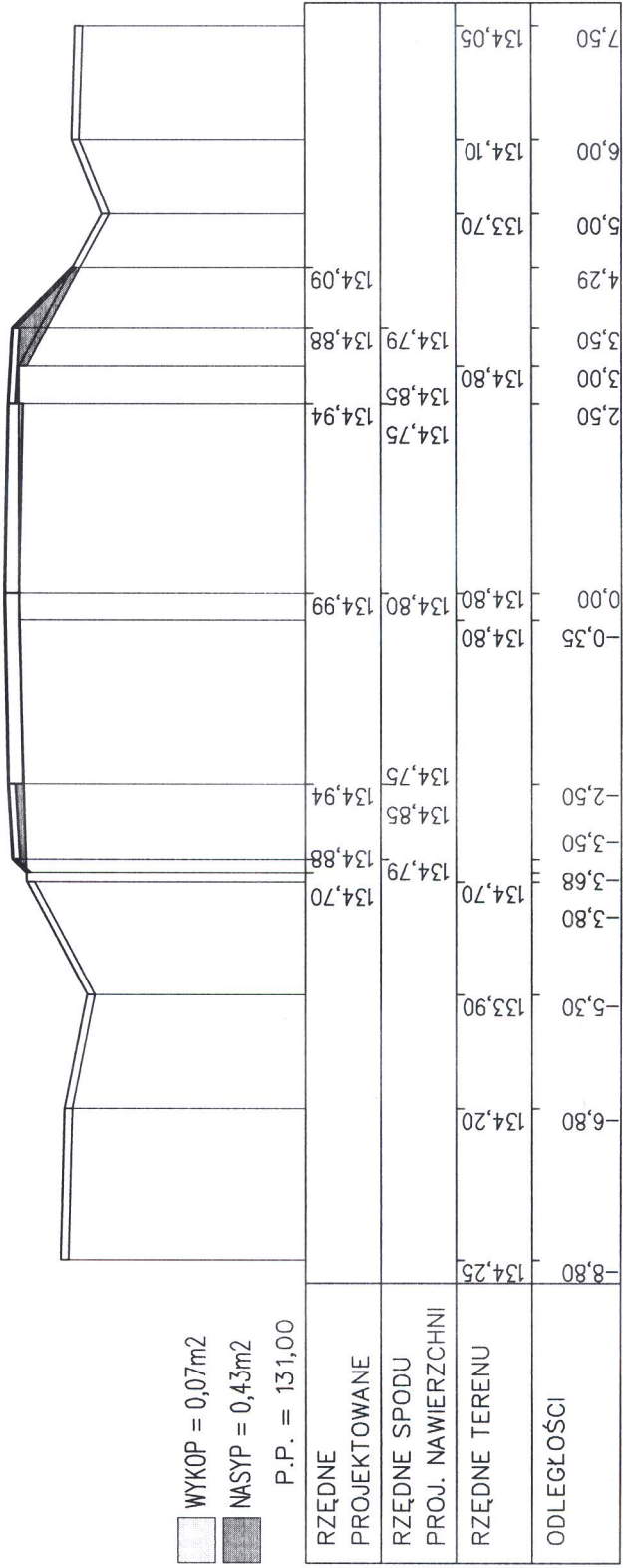

PIK. 2976,56

Skala 1:100 / 1:100

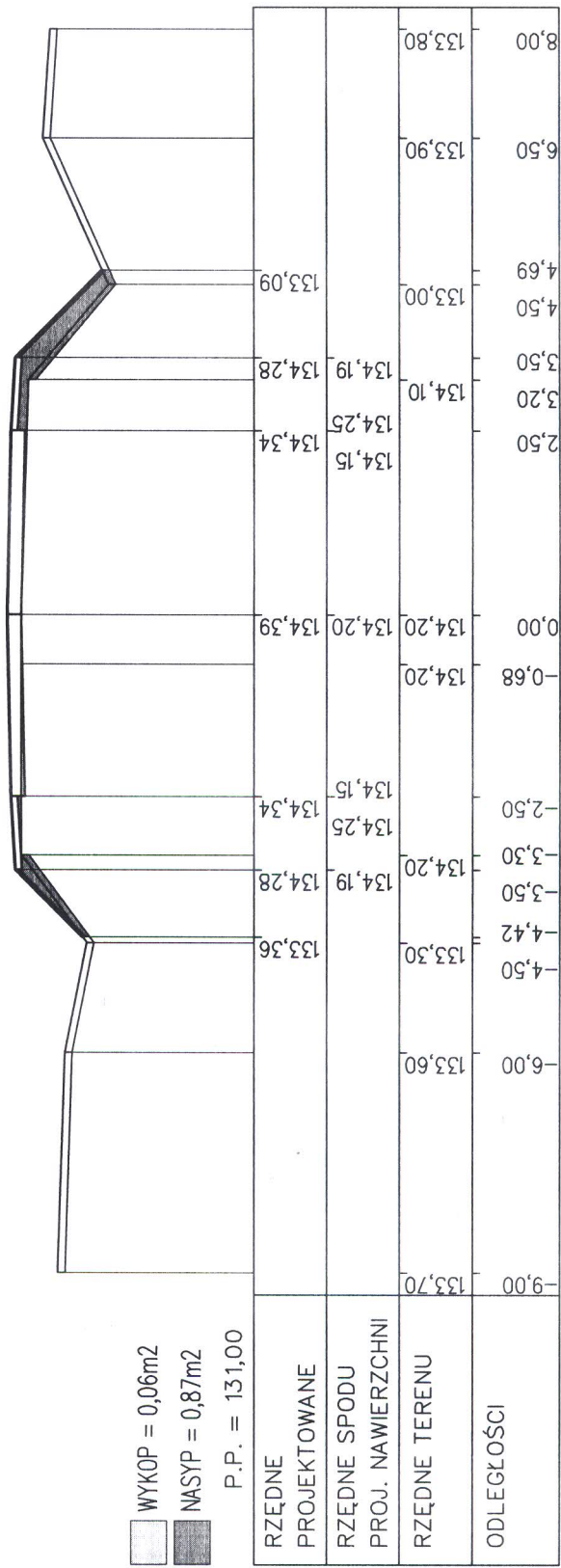





PIK. 3193,59

Skala 1:100/1:100

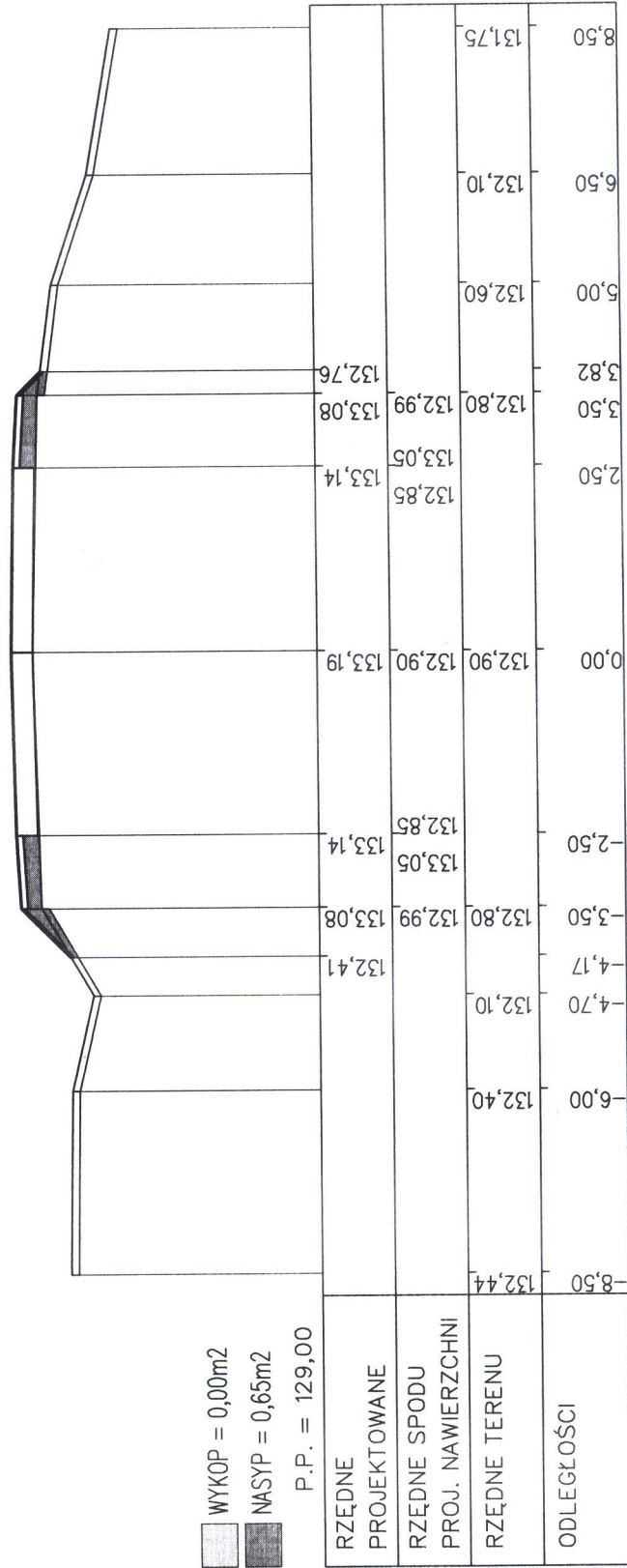

PIK. 3285,69

Skala: 1:100/1:100

WYKOP = 0,13m<sup>2</sup>  
 NASYP = 0,33m<sup>2</sup>  
 P.P. = 129,00

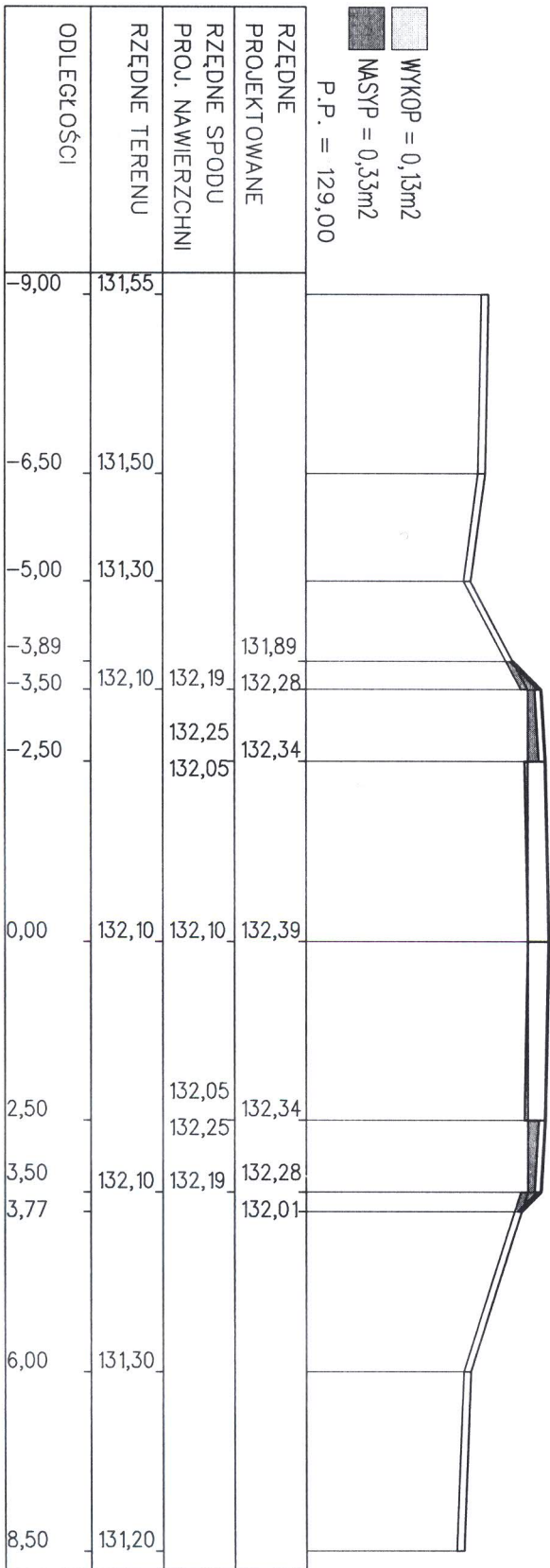

PIK. 3341,90

Skala 1:100/1:100

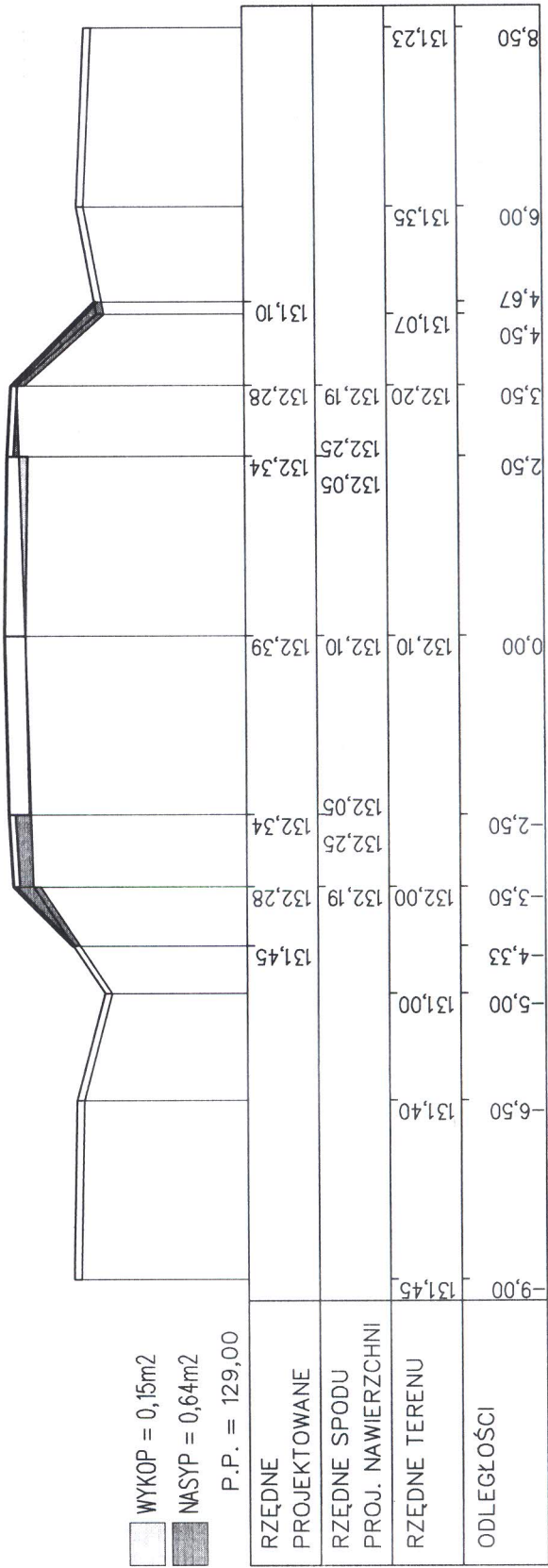

PK. 3395,25

Skala 1:100/1:100

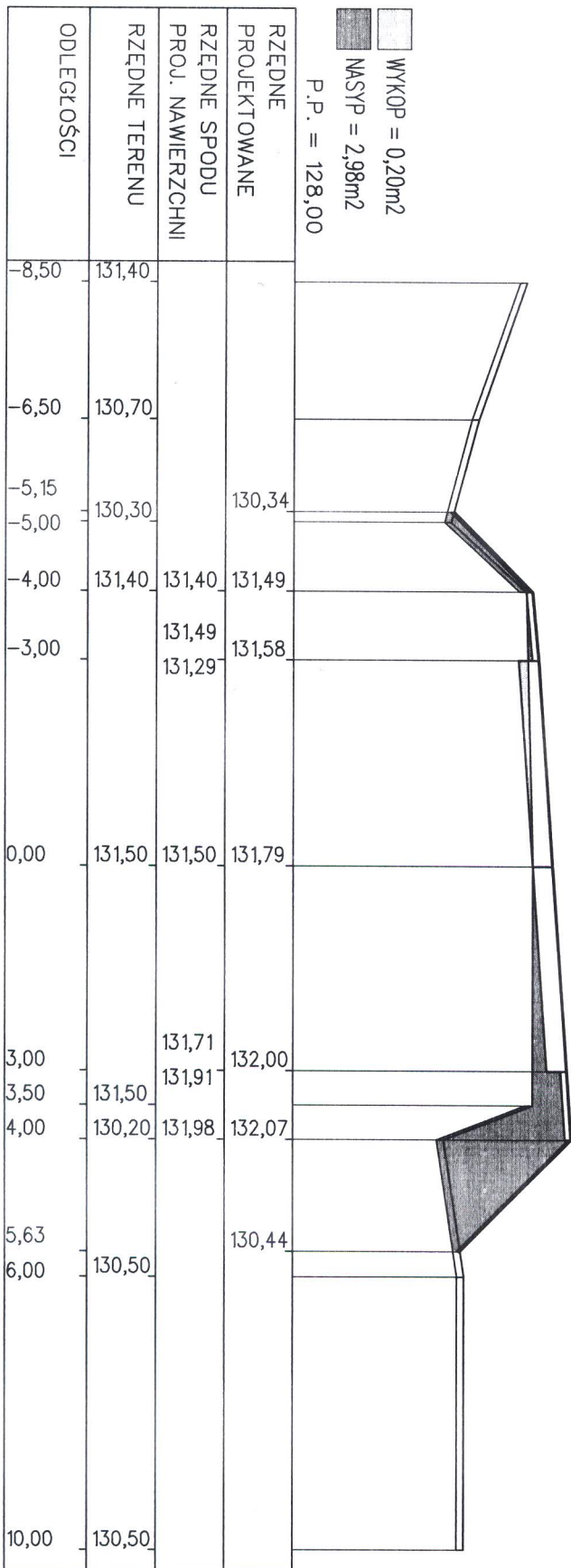



PIK. 3499,00  
 Skala 1:100/1:100

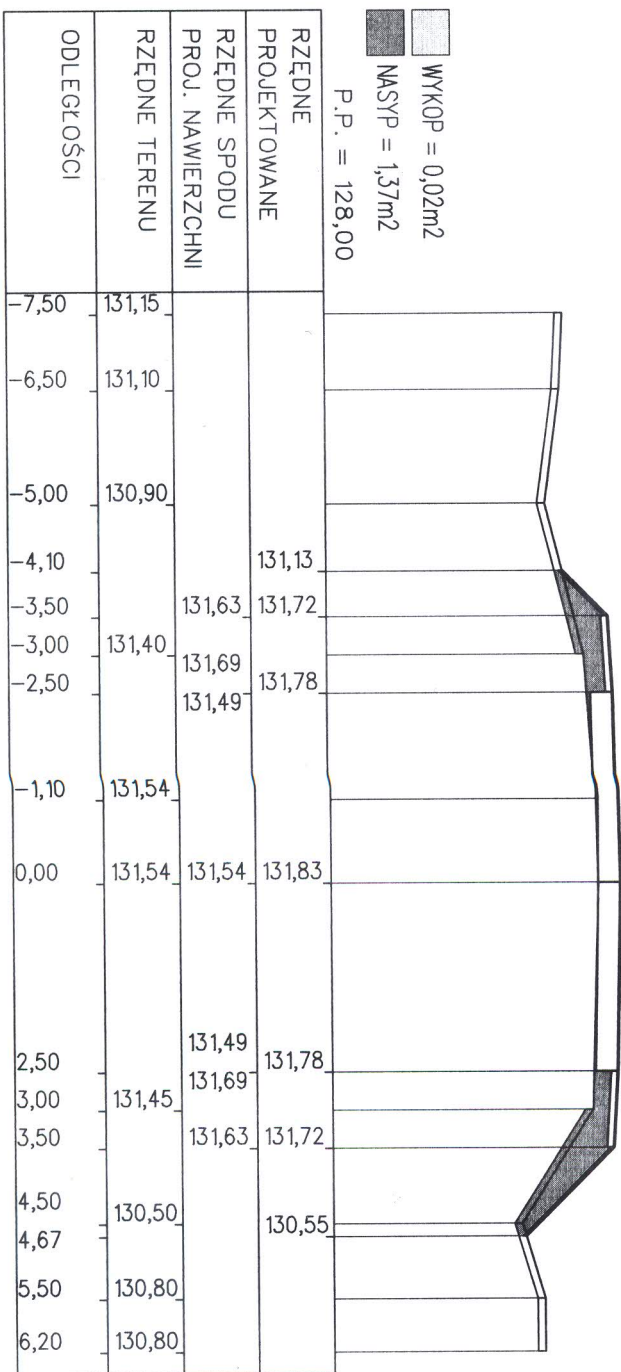

PIK. 3579,75

Skala 1:100/1:100

WYKOP = 0,03m<sup>2</sup>  
 NASYP = 0,58m<sup>2</sup>  
 P.P. = 129,00

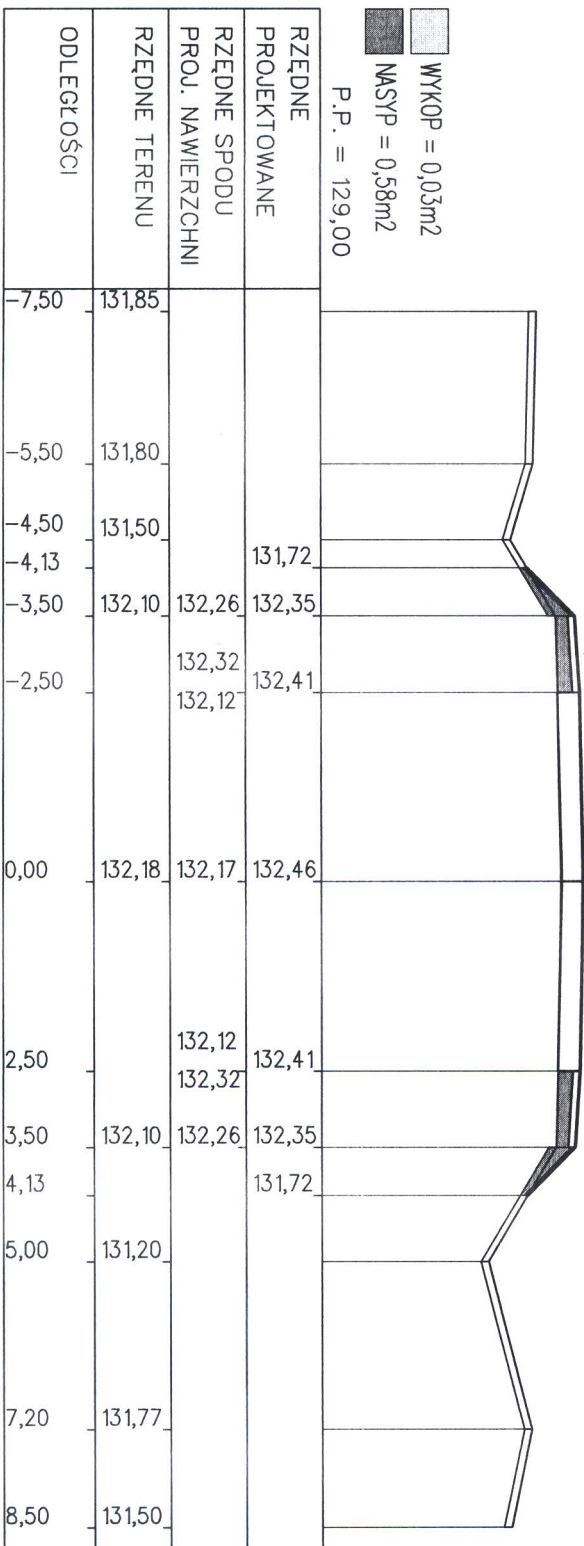

PIK. 3659,74  
 Skala 1:100/1:100

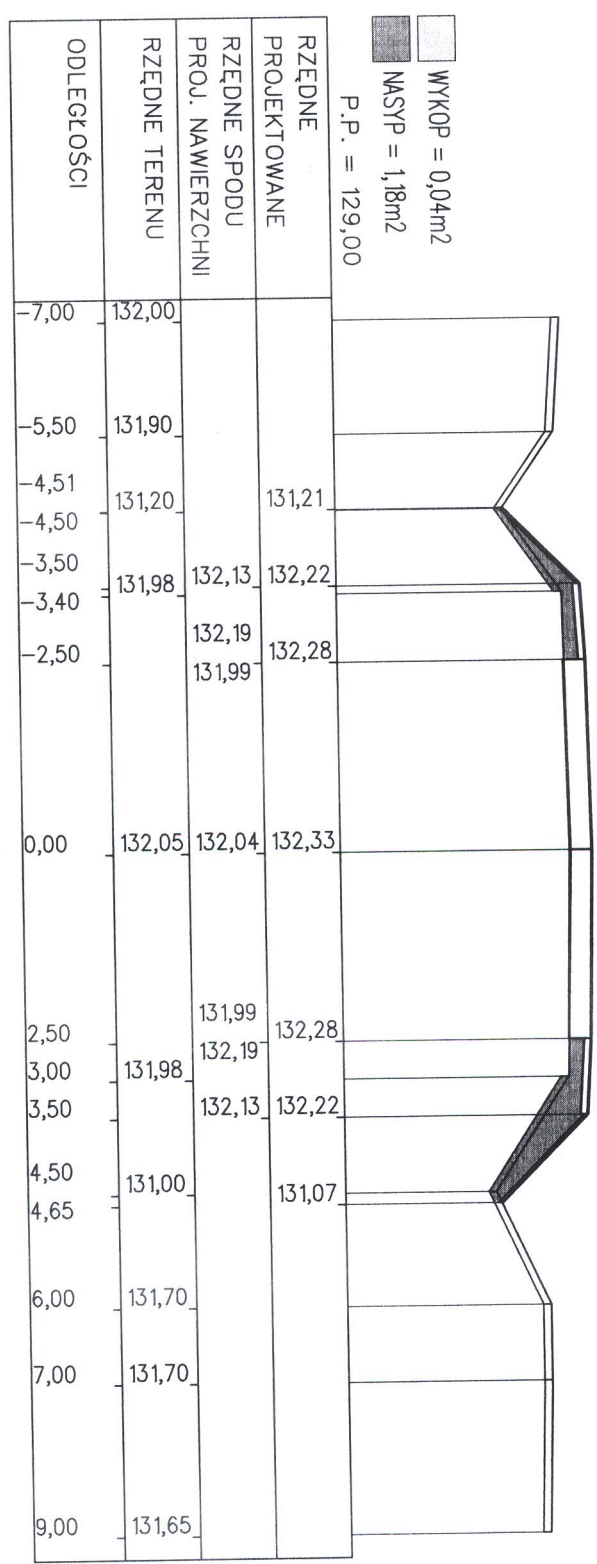

PIK. 3756,58

Skala 1:100/1:100

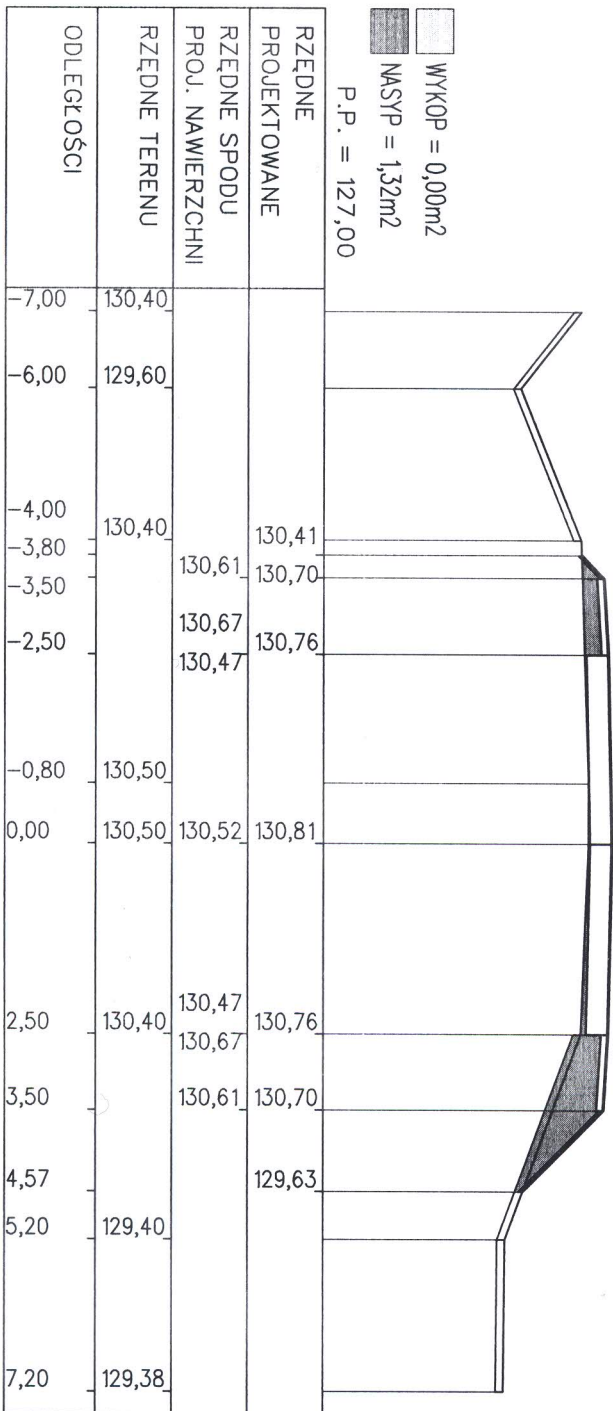



PIK. 3818,00

Skala 1:100/1:100

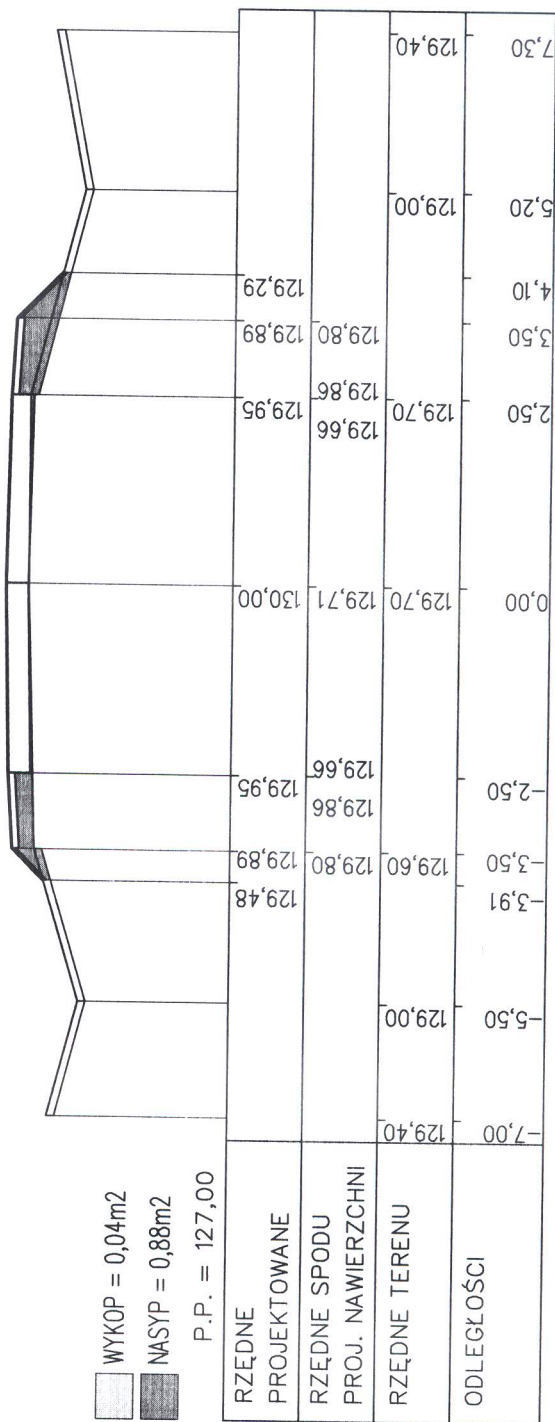

PIK. 3929,28

Skale 1:100/1:100

WYKOP = 0,06m<sup>2</sup>

NASYP = 0,53m<sup>2</sup>

P.P. = 127,00

